

# FlightMax™

Flight Situation Display

---

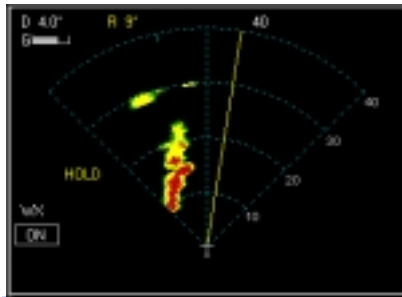

## FlightMax Radar

(RDR-130/150/160)

Part Number 600-0059 Revision 00

### Revision History

Date	Revision	Description
Sep. 7, 2000	00	Production Release

© Copyright 2000  
**Avidyne Corporation**  
55 Old Bedford Road  
Lincoln, Massachusetts 01773  
Web Site: [www.avidyne.com](http://www.avidyne.com)

Bendix/King ® is a registered trademark of Allied Signals, Inc.

# FlightMax Radar Contents

<b>Introduction</b>	<b>1</b>
<b>Radar Safety</b>	<b>2</b>
Maximum Permissible Exposure Level .....	2
Safe Radar Operation .....	3
<b>Radar Overview</b>	<b>5</b>
<b>Radar Pages and Menus</b>	<b>6</b>
Radar's Data Page .....	6
Radar Main Menu .....	9
<b>How to Use Radar</b>	<b>15</b>
Radar Startup .....	15
Pre-takeoff Check .....	15
Test .....	16
Turning the Radar On/Off .....	16
Displaying Weather .....	16
Displaying Ground Map Data .....	17
Changing the Antenna's Tilt .....	17
Displaying the Bearing Line .....	17
Enable Echo Warnings .....	18
Range Control .....	18
Outer Knob Functions .....	18
Changing Beam Altitude .....	18
<b>Messages and Error Indications</b>	<b>19</b>
Echo Ahead .....	20
Low Ground Speed Warning .....	21

## Figures

Figure 1: Radar Icon .....	1
Figure 2: Maximum Permissible Exposure Level .....	3
Figure 3: Radar Data Page .....	6
Figure 4: Radar Main Menu .....	9
Figure 5: Function Menu .....	9
Figure 6: Radar Test Pattern .....	10
Figure 7: Mode Menu .....	11
Figure 8: Ground Mapping Display .....	12
Figure 9: Settings Menu .....	14
Figure 10: Echo Ahead .....	20

## Tables

Revision History .....	ii
Table 1: Rainfall Rate Color Coding .....	8
Table 2: Messages Issued by Radar .....	19

# FlightMax Radar

## Introduction

This part of the Pilot's Guide, explains FlightMax Radar.

FlightMax Radar is an interface, control and display function for airborne weather radar systems. It duplicates the weather display functions of the original equipment indicators supplied with the following Bendix/King radar's: RDR-130/150/160. Topics include:

- *Radar Safety* - general radar safety information.
- *Radar Overview* - presents an overview of the Radar function.
- *Radar Pages and Menus* - explains all pages and menus used in Radar.
- *How to Use Radar* - explains how to perform specific tasks using Radar.
- *Messages and Error Indications* - provides the meanings of Radar messages and error indications.
- *Menu Tree* - shows the path to any menu in Radar.

FlightMax Radar is verified by the presence of its icon and text label in the Main Menu. If Radar's icon and label, shown in Figure 1, are not present in the Main Menu, contact your installer for assistance.



Figure 1: Radar Icon

## Radar Safety

---

Aircraft weather radar is specifically designed to emit a concentrated beam of microwave energy at potentially hazardous power levels. These hazards include the possibility of injury to ground personnel, ignition of flammable materials, including fuel, and damage to sensitive electronic devices. As the pilot in command, you are responsible for management of the radar system so as to eliminate these hazards.

The FAA has published an Advisory Circular, AC 20-68B, *Recommended Radiation Safety Precautions for Airborne Weather Radar*, that gives good basic guidelines for safe radar operation. The Advisory Circular has been included in Appendix 1 at the end of this section. Please read it thoroughly and observe its recommendations.

### Maximum Permissible Exposure Level

U.S. Government standards for human exposure to microwave radiation permit a maximum level of 10 mW per square centimeter. When the radar is operating, this level may be exceeded within the area indicated in Figure 2. According to information published by the manufacturer of your antenna/receiver/transmitter (ART), strict observance of this boundary whenever your radar is operating should provide adequate protection.



Exposure of ground personnel or other aircraft occupants to microwave energy emitted at positions within the MPEL boundary depicted in Figure 2 may be hazardous. Beware that the MPEL boundary is determined with respect to the antenna, not the radome or any other aircraft structure. The MPEL boundary shown in Figure 2 applies only to units specifically approved for use with FlightMax Radar. The MPEL boundary shown in Figure 2 does not guarantee protection against ignition of flammable materials or damage to sensitive electronic equipment exposed to microwave energy from your radar.

---

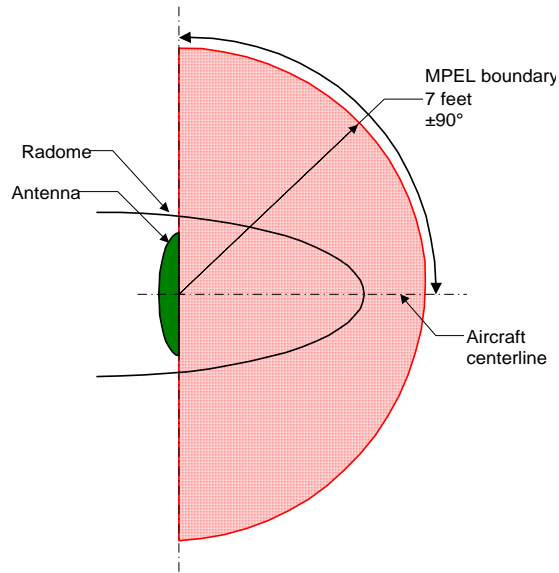

Figure 2: Maximum Permissible Exposure Level

## Safe Radar Operation



### CAUTION

In the event of a system malfunction, the radar could be on and emitting microwave radiation any time the FSD is on. If a malfunction of any sort is suspected, turn off the FSD and disable the radar by turning off the circuit breaker.

Based on the recommendations made by the FAA and by the manufacturer of your radar unit, Avidyne recommends the following safety procedures:

- At system startup, if the radar is not being used in flight, leave it off.
- At startup, if the radar is being used during the flight, switch to standby as soon as possible.

- Set the radar to TEST whenever it is convenient to do so in pre-takeoff checks. No microwave radiation is emitted in TEST operation. Never turn the radar ON without first checking its operation with TEST.
- Never turn the radar ON while on the ramp under any circumstances.
- To complete the pre-takeoff check or to check weather before takeoff, turn the radar ON while taxiing well clear of ground personnel, ground apparatus and other aircraft. Leave it ON for the minimum time necessary to verify proper operation of the radar or view the weather. If necessary, repeat on the runup pad with caution. Return to STANDBY when the checkout is finished.
- If radar is to be used during takeoff, do not switch it to ON until you are number one at the hold short line.
- Return the radar to STANDBY or OFF immediately after clearing the runway on landing. Do *not* continue to operate the radar while taxiing.



## Radar Overview

---

Radar systems measure and map rainfall intensity within a scanned area. While rainfall itself is not generally hazardous to flight, intense rainfall may include severe turbulence which can be hazardous. A radar system can only display what it scans. If the antenna is not properly aligned, significant precipitation may be missed. Avoiding severe weather requires the pilot to have a complete understanding of the capabilities and limitations of his radar system, an understanding of thunderstorm dynamics, and up-to-date forecasts so as to avoid likely areas of severe weather.

FlightMax Radar provides access to all of the weather avoidance functions available with the original antenna/receiver/transmitter (ART) unit. As the radar scans, it collects and maps rainfall intensity over a specific area to the left and right of your aircraft's heading. The intensity of rainfall at any given location is indicated by the color displayed at that point.

FlightMax Radar is also available to the Map function of the FlightMax FSD. The Map function is a terrain and navigation display with overlays of radar, traffic and lightning data. The Avidyne Radar function provides radar data to the Map function for possible overlay display.

## Radar Pages and Menus

---

### Radar's Data Page

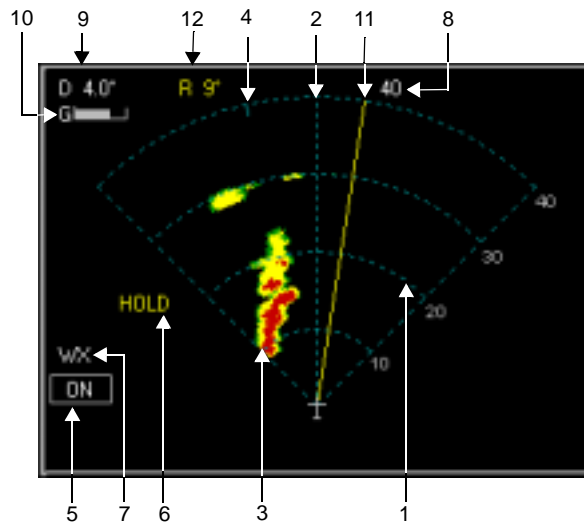

Figure 3: Radar Data Page

1. **Range Rings** - Scan limits and range rings are shown as dotted light blue lines. Range labels indicate the distance to each of the range rings.
2. **Heading Reference Line** - Marks the center of the scan area.
3. **Rainfall Echos** - Rainfall data returned from the ART, are displayed as color coded echos. See Table 1 for color meanings.
4. **Scan Indicator (Beam View™)** - The current position of the scan is shown by BeamView, a highlighted arc (as shown in Figure 3). Scan width of the arc is set at the Settings menu by your installer based on your antenna size. BeamView can be turned off and a small tic mark will indicate the position of the scan. Precipitation data is constantly updated as the radar scans.
5. **Function** - The function annunciation (ON, TEST, SBY, OFF) indicates the function status.

6. **Hold Flag** - The Hold flag indicates that the system is displaying a frozen representation of previously scanned data.
7. **Mode** - Mode (Wx, WxA, GND) defines how the radar is being used. Wx and WxA orient the radar to weather phenomenon. Ground Mapping (GND) orients the radar to ground features.
8. **Range** - The Range number , indicates range intervals within the scale. The top most number indicates the the current selected range scale.  
**Beam Altitude (TiltView™) (not shown)**- The Beam Altitude numbers represent (in thousands of feet) the relative altitude of the center of the radar beam in relation to the aircraft's altitude at the distance shown above each number.
9. **Tilt** - Tilt indicates the angle and direction of the radar antenna: U for up, D for down and the amount of antenna tilt in quarter degrees, using decimal notation.
10. **Gain** - Receiver gain is shown on a bar whose length indicates fraction of full gain. It is shown only in ground mapping mode, since gain is not controllable in weather and weather alert modes.
11. **Bearing Line** - The bearing line provides the relative bearing to any feature displayed on the screen. The bearing line is controlled by the outer knob. It disappears from the screen after 15 seconds of non-use.
12. **Bearing** - The relative bearing of the Bearing line is given at the top of the screen – L for left, R for right and the number of degrees relative to the aircraft heading when it is selected.

**Color Coding**

FlightMax Radar indicates the rainfall rate by color. All standard radar indicators use a similar color coding system. Color usage is explained in Table 1.

**Table 1: Rainfall Rate Color Coding**

<b>Rate (mm/hour)</b>	<b>Color</b>	<b>Interpretation</b>
<1	Black	Generally safe when away from other returns
1-4	Green	Use caution and observe for changes
4-12	Yellow	Caution-avoid whenever possible
12-50	Red	Danger- avoid at all times



**CAUTION**

FlightMax Radar is intended as a severe weather avoidance tool only. Penetrating cells or lines of cells is extremely dangerous with or without radar and must not be attempted. Give thunderstorms a wide berth. The flight precautions given in Table 1 are intended for highly proficient instrument pilots.

---

## Radar Main Menu

The Radar main menu (Figure 4) provides access to all the operating functions used to control the radar system and options for changing the radar display.

## Function

The radar Function menu (Figure 5) controls four functions: RADAR ON, TEST, STANDBY, and RADAR OFF. They are described below.

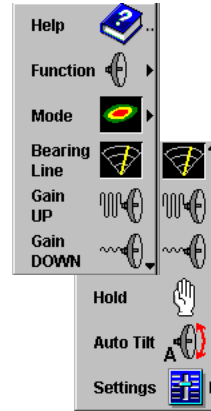

Figure 4: Radar Main Menu

## On

Selecting FUNCTION→ON places the radar in normal operation. The antenna scans and the Receiver/Transmitter (R/T) transmits microwaves so as to detect precipitation. Confirmation that the radar is on is indicated by the presence of the moving scan indicator, radar echos, and the ON screen annunciation.

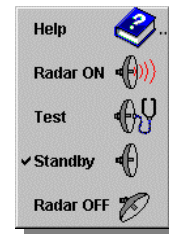
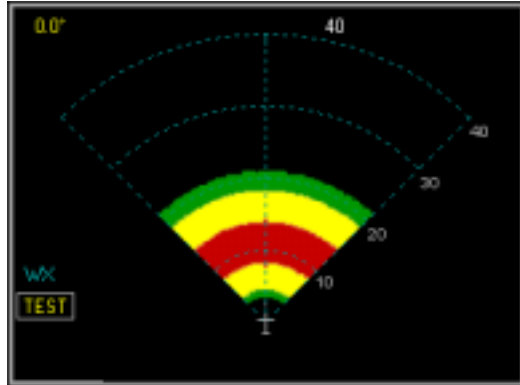

Figure 5: Function Menu

## Test

Selecting FUNCTION→TEST initiates a radar self-test function that is monitored by the FlightMax FSD. The test function is confirmed by the presence of the TEST annunciation and the test display (Figure 6).

During self test, all of the circuitry and functions of the ART are exercised with the exception of the magnetron tube. No microwave energy is emitted in the test function. The test pattern display should follow the pattern shown in Figure 6 (green, yellow, red, yellow, green). If it does not, it indicates possible problems with the system that should be corrected before use.



**Figure 6: Radar Test Pattern**

**Standby**

Selecting FUNCTION→STANDBY places the radar circuitry in an energized but inactive state. STANDBY Should be selected as soon as practical after starting the FSD. While in STANDBY, the magnetron tube in the ART is kept warm so the radar can be used immediately upon switching it on.

Confirmation that the radar is in standby is indicated by the absence of the moving scan indicator, no radar echo returns, and the SBY screen annunciation.

Standby mode also places the antenna Tilt in a 'Park' position as set by the installer. The park position places the antenna in one of the following positions: last position (at last shutdown), full up, centered (0°), or full down.

**Off**

Selecting FUNCTION→RADAR OFF removes power from the ART, disabling the radar. The antenna does not scan and no microwave energy is emitted.

Confirmation that the radar is off is indicated by the OFF annunciation on the data screen, along with the absence of radar returns and the moving scan indicator on the data screen. The radar system is off any time the FSD is off and will never be turned on except by direct action.



## CAUTION

In the event of a system malfunction, the radar could be on and emitting microwave radiation any time the FSD is on. If you have any reason to suspect the radar is on, turn off the FSD or disable the radar by means of its circuit breaker before approaching ground personnel, equipment or other aircraft. Do not turn it on again except for diagnostic purposes at a safe distance from personnel and equipment.

---

### Mode

The RADAR→MODE submenu provides for three operating options. There are three operating modes: Wx, WxA or Gnd Map. Only one mode may be used for operation.



Figure 7: Mode Menu

#### Wx

The Weather mode is the normal mode using during flight. Rainfall echos are displayed as color contours.

#### WxA

The weather alert mode operates the same as Wx mode but contains an additional feature. The red areas (the most severe conditions) flash between red and black as a further visual cue of the most hazardous conditions.

#### GndMap

Ground mapping mode orients the radar to ground features (Figure 8). By tilting the antenna down and varying the gain as necessary to get an intelligible image, coastlines, promontories, forested areas etc., can be displayed.

While in ground mapping mode the radar's receiver gain may be needed to bring in a display. The GAIN UP and GAIN DOWN functions are only enabled during the ground map mode. At startup the gain is set for maximum, the grey bar extends all the way across the scale.

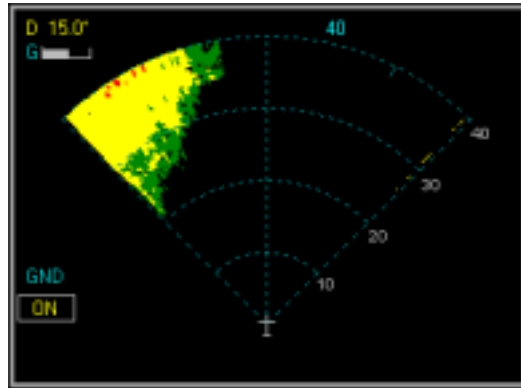

**Figure 8: Ground Mapping Display**

### **Bearing Line**

A bearing line display is available within Radar. The bearing line is a yellow line drawn from the depicted aircraft position to the outer edge of the range field. The bearing line provides the pilot with an approximate bearing to a region of weather, or lack thereof.

The outer knob is used to move the bearing line right or left. The bearing line remains on screen until it is deselected or there is no knob movement for 15 seconds. Then the outer knob function reverts back to “Tilt” control.

### **Gain Up and Gain Down**

The gain control changes the attenuation of the received signal (to the receiver portion) of the radar when in the ground mapping mode. Changing the gain is sometimes used to better examine the structure of heavy echo areas. Gain should normally remain at maximum (“full”).

The gain up and gain down functions are only available while in the GNDMAP mode. They are grayed out (inactive) when in other modes. The screen annunciation is a gray bar in the upper left corner of the screen. Maximum gain is indicated by a fully extended bar across the scale.



## Hold

Hold is used to freeze the current radar echo display. The radar continues to scan, but the returns are not displayed. While HOLD is active, a screen annunciation to the left of the scanned area tells the pilot the display is no longer being updated. This allows the pilot to pause screen updates for a time, then examine changes when Hold is deactivated. Upon deactivation of HOLD, Radar resumes the normal display update from newly scanned data.

## Auto-Tilt

Auto-Tilt automatically adjusts the radar antenna to maintain a constant, approximate antenna position from the point of activation. There is also compensation due to aircraft maneuvering in non stabilized radar installations. The amount of tilt is based on the altitude input and range selection. As the Range and altitude settings are changed, the Auto-Tilt will reposition the center of the radar beam at the edge of the displayed range, to the same altitude above ground, ( $\pm 10\%$ ).

To operate AutoTilt, the pilot levels off at the desired altitude and Auto-Tilt will activate. Any further changes in altitude and range adjustment is compensated for in Tilt. During operation, Auto-Tilt, lowers the tilt when Range is decreased in order to see approximately the same amount of ground returns at the edge of coverage, and raises tilt when Range is increased. Also, tilt is adjusted inversely with altitude changes to keep the radar beam at an approximate constant height above ground.

On system startup, Auto-Tilt is deactivated and the antenna position is left in its park position. Selecting Auto-Tilt from the radar main menu, sends a command to the radar sensor, which places it in the Auto-Tilt operating mode. A checkmark appears beside the Auto-Tilt menu item.

**NOTE:** Manual tilt control is not available when Auto Tilt is active.

## Settings

The Settings menu provides access to certain radar “settings”. They include the following:

### Echo Warnings

Selecting this function allows for enabling or disabling of the Echo warnings function, which is used to display echo ahead warning messages in the message bar. See the Messages and Error Indications section for more information Echo Ahead messages. Once this parameter has been set it will be maintained from use to use.

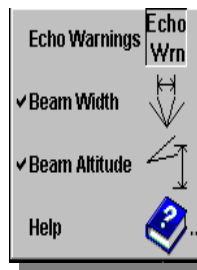

Figure 9: Settings Menu

### Beam Width (BeamView) display

Selecting this function enables or disables the BeamView display. BeamView depicts a moving wedge across the radar screen that follows the sweep of the radar antenna. This wedge is sized to represent the actual beam width and is drawn in the black area of the normal sweep, underneath any echo information. The actual beam width is determined in the Radar Setup page and is based on the actual beam width of your specific R/T. Setup of the beam width should be done by your installer.

### Beam Altitude (TiltView) display

Selecting this function turns On/Off the TiltView display. The TiltView numbers are depicted next to each range ring distance on the radar data page, in yellow. The numbers represent (in thousands of feet) the relative altitude of the center of the radar beam in relation to the aircraft’s altitude. The beam altitude numbers take into account the Tilt and Range settings.

**NOTE:** In non stabilized radars the number value is only correct in straight and level flight.

## How to Use Radar

---

### Radar Startup

FlightMax Radar starts automatically as part of the normal initialization sequence of the FSD. To use RADAR do the following:

1. Turn the FSD on. The unit will go through its normal startup sequence.
2. Press **Enter** when prompted. This will bring up the Map display.
3. Press **Escape** to bring up the Main Menu.
4. Select Radar from Main Menu.
5. Radar then displays its data page and main menu. Radar restores all mode selections that were active when it was last used.

### Pre-takeoff Check

While at a safe distance from ground personnel, equipment and other aircraft, briefly turn the radar on and tilt the antenna below zero degrees.



### WARNING

Do not turn your radar on except in accordance with the safety recommendations given in the Radar Safety section.

---

- Watch for the appearance of ground reflections, verifying that the ART is operating properly and that the antenna tilt is working correctly.
- Tilt the antenna through its full range, verifying appropriately changing images of objects on the ground below zero degrees, fading as you move through the horizon, to be replaced by images of any weather that may be present as you tilt the antenna up.

Turn the radar off as soon as possible after this test.

## Test

Use the FUNCTION→TEST mode before every flight where radar is going to be used. Make it a part of the pre-takeoff checklist. The radar should be off and the FSD on, prior to performing a self test.

1. From the FUNCTION menu select stdby.  
Placing the radar in standby allows the magnetron tube to warm up. It should take approximately 2 minutes.
2. After the tube is warm, select test from the FUNCTION menu.  
While in test also check for:
  - proper operation of the range control (the pattern should change appropriately with selected range)
  - for proper operation of weather alert (WxA) mode (the red band should flash).

## Turning the Radar On/Off



### WARNING

Do not turn your radar on except in accordance with the safety recommendations given in the Radar Safety section.

---

To turn the radar on, go to Radar's main menu and select FUNCTION→ON.

To turn the radar off, go to Radar's main menu and select FUNCTION→OFF

## Displaying Weather

1. In Radar's main menu, select MODE→WX for normal weather display or MODE→WXA for "weather alert" mode (i.e., red echos flash).
2. Tilt the antenna as necessary to visualize weather at, above or below your altitude.

## Displaying Ground Map Data

1. In radar's main menu, select MODE→GND MAP.
2. Tilt the antenna and vary the gain as necessary to get a useful image.
3. Gain is controlled only in ground map mode.  
From Radar's main menu, select gain up or gain down to increase or decrease the R/T's gain.

## Changing the Antenna's Tilt

1. Ensure that the bearing line is not active. If it is active, deselect the function.
2. Rotate the outer cursor control knob to manually adjust the antenna's tilt.  
The annunciation is in the upper left corner of the display screen. Tilt values are in degrees and range from D15.00° (DOWN) to U15.00° (UP). The outer knob only adjusts 'Tilt' when the 'Bearing Line' is not selected.
3. The tilt can also function automatically.  
From Radar's main menu select Auto Tilt to activate automatic tilt control.

## Displaying the Bearing Line

1. In Radar's main menu, select BEARING LINE.  
A yellow line will appear on the center line azimuth and a yellow annunciation indicating the direction (right or left) and the value (in one degree increments) is displayed above the range field.
2. Rotate the outer cursor control knob to position the bearing line.
3. The bearing line will automatically disappear after 15 seconds of disuse.

## Enable Echo Warnings

1. From radar's main menu, select SETTINGS→ECHO WARNINGS.
2. An area forming a 22° wedge from the nose of the aircraft is checked for total echos (indicating rainfall).
3. If there are storm indications ahead, the message bar will display RADAR ECHOS AHEAD or HEAVY RADAR ECHOS AHEAD depending upon the intensity of the storms.

## Range Control

1. The inner, knob always controls the range scale except during system calibration (which is done by your installer).
2. Turn the knob clockwise to increase the scale and counter clockwise to decrease the scale.

## Outer Knob Functions

The large, outer knob controls either antenna tilt, bearing line position, or Roll Trim (RDR-1100) depending on your selection.

The Outer Knob's function is annunciated by an icon and text in the lower right of the screen that is visible when the menu is visible.

## Changing Beam Altitude

Beam Altitude is adjusted in conjunction with the range and antenna tilt. There is no independent control of Beam Altitude.

Adjusting the antenna tilt with the outer knob or adjusting the range with the inner knob will also change the beam altitude.

## Messages and Error Indications

---

**Table 2: Messages Issued by Radar**

<b>Message</b>	<b>Meaning</b>
RADAR ECHOS AHEAD	Indicates presence of significant green and/or yellow echos within the currently selected range and $\pm 22^\circ$ of the aircraft heading. Generated only when an option other than Radar is being displayed.
HEAVY RADAR ECHOS AHEAD	Indicates presence of significant red echos within the currently selected range and $\pm 22^\circ$ of the aircraft heading. Generated only when an option other than Radar is being displayed.
SPEED BELOW 20 KTS – TURN RADAR OFF	Radar is ON (scanning) and GPS-reported ground speed is below 20 kts, suggesting that you have landed. Displayed only when an option other than Radar is being displayed.
BAD GROUND SPEED INPUT; NOTE RADAR IS ON	Radar is turned on and GPS-is not reporting valid ground speed. Displayed only when an option other than Radar is being displayed.
Groundspeed Input Operational	Ground speed data has been restored.
LOSS OF RADAR DATA	Communication with the radar sensor has been lost – no data is available.
RADAR SENSOR DATA RESTORED	Communication with the radar sensor has been restored.
RADAR ERROR	An error has occurred in the radar sensor system. This message will appear in four different cases and R/T Fault (general).

**Table 2: Messages Issued by Radar**

Message	Meaning
RADAR ERROR CLEARED	The previously reported error in the radar sensor system has been corrected
RADAR FAILURE	The radar system has failed. This error will <i>not</i> be cleared until the system is shut down and restarted.

### Echo Ahead

The Echo Ahead warning monitors a predetermined area for significant radar returns while viewing other FSD functions. The alert is displayed in the message bar.

The monitored area (Figure 10) is a wedge 22° to either side of the aircraft nose to the range limit currently in use. Within this area, Radar checks the total indicated rainfall. Above a predetermined level of green/yellow content, Radar displays the message, “RADAR ECHOS AHEAD”. Above a predetermined level of red content, Radar instead displays the message, “HEAVY RADAR ECHOS AHEAD”.

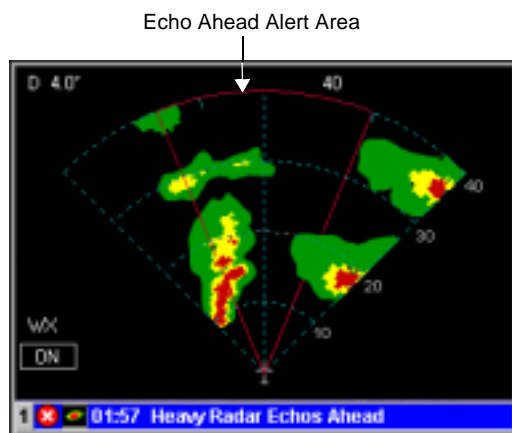

**Figure 10: Echo Ahead**



## Low Ground Speed Warning

The Low Ground Speed Warning is a reminder to turn off the radar upon landing. FlightMax Radar monitors the ground speed reported by the GPS and, when your ground speed falls below 20 knots, the FSD displays a message in the Message Bar indicating “SPEED BELOW 20 KTS. – TURN RADAR OFF”.

If Radar is unable to obtain a valid ground speed from the system’s GPS interface while the radar is on, it displays the message “BAD GNDSPD INPUT; NOTE RADAR IS ON” in the Message Bar.



### CAUTION

It is the pilot in command’s responsibility to insure that the radar is turned off after landing. Do not rely on the low ground speed message to prompt you to do so. We recommend that you make it a checklist item to turn off the radar after exiting the runway.

---

# Menu Tree

---

The following Menu Tree graphically depicts the paths to all the Radar menu functions.

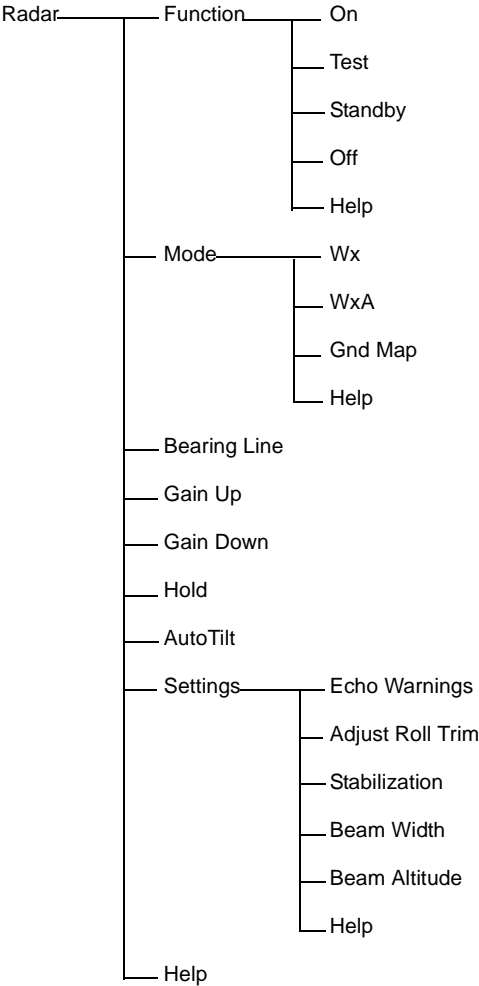

## **Appendix 1 - AC 20-68B**

### RECOMMENDED RADIATION SAFETY PRECAUTIONS FOR GROUND OPERATION OF AIRBORNE WEATHER RADAR

Department of Transportation

Federal Aviation Administration

8/8/80

Initiated by: AFO-512

1. **PURPOSE.** This circular sets forth recommended radiation safety precautions to be taken by personnel when operating airborne weather radar on the ground.
2. **CANCELLATION.** AC 20-68A, dated April 11, 1975, is canceled.
3. **RELATED READING MATERIAL.**
  - a. Barnes and Taylor, Radiation Hazards and Protection (London: George Newnes Limited, 1963), p. 211.
  - b. U.S. Department of Health, Education and Welfare, Public Health Service, Consumer Protection and Environmental Health Service, "Environmental health microwaves, ultraviolet radiation and radiation from lasers and television receivers - An Annotated Bibliography," FS 2.300: RH-35, Washington, U.S. Government Printing Office, pp. 56 - 57.
  - c. Mumford, W. W., "Some technical aspects of microwave radiation hazards," Proceedings of the IRE, Washington, U.S. Government Printing Office, February 1961, pp. 427 - 447.
4. **BACKGROUND.** Dangers from ground operation of airborne weather radar include the possibility of human body damage and ignition of combustible materials by radiated energy. Low tolerance parts of the body include the eyes and testes.
5. **PRECAUTIONS.** Management and supervisory personnel should establish procedures for advising personnel of dangers from operating airborne weather radars on the ground. Precautionary signs should be displayed in affected areas to alert personnel of ground testing.
  - a. General.
    - (1) Airborne weather radar should be operated on the ground only by qualified personnel.

- (2) Installed airborne radar should not be operated while the aircraft is in a hangar or other enclosure unless the radar transmitter is not operating, or the energy is directed toward an absorption shield which dissipates the radio frequency energy. Otherwise, radiation within the enclosure can be reflected throughout the area.
- b. Body Damage. To prevent possible human body damage, the following precautions should be taken:
    - (1) Personnel should never stand nearby and in front of a radar antenna which is transmitting. When the antenna is not scanning, the danger increases.
    - (2) A recommended safe distance from operating airborne weather radars should be established. A safe distance can be determined by using the equations in Appendix 1 [omitted] or the graphs of figures 1 and 2 [omitted]. This criterion is now accepted by many industrial organizations and is based on limiting exposure of humans to an average power density not greater than 10 milliwatts per square centimeter.
    - (3) Personnel should be advised to avoid the end of an open waveguide unless the radar is turned off.
    - (4) Personnel should be advised to avoid looking into a waveguide, or into the open end of a coaxial connector or line connector to a radar transmitter output, as severe eye damage may result.
    - (5) Personnel should be advised that when high power radar transmitters are operated out of their protective cases, X-rays may be emitted. Stray X-rays may emanate from the glass envelope type pulser, oscillator, clipper, or rectifier tubes, as well as magnetrons.
  - c. Combustible Materials. To prevent possible fuel ignition, an installed airborne weather radar should not be operated while an aircraft is being refueled or defueled.

/s/

M. C. BEARD Director of Airworthiness